

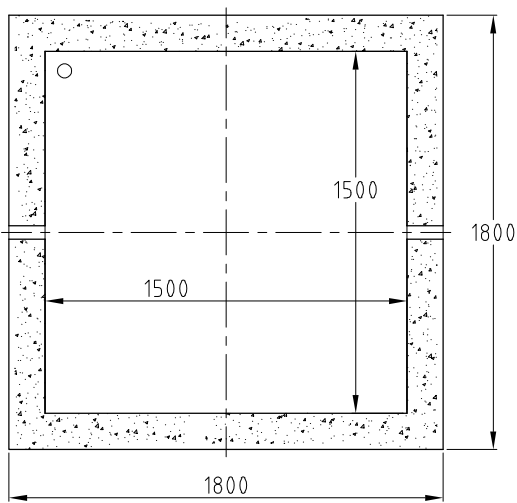

Peso: 1480 kg

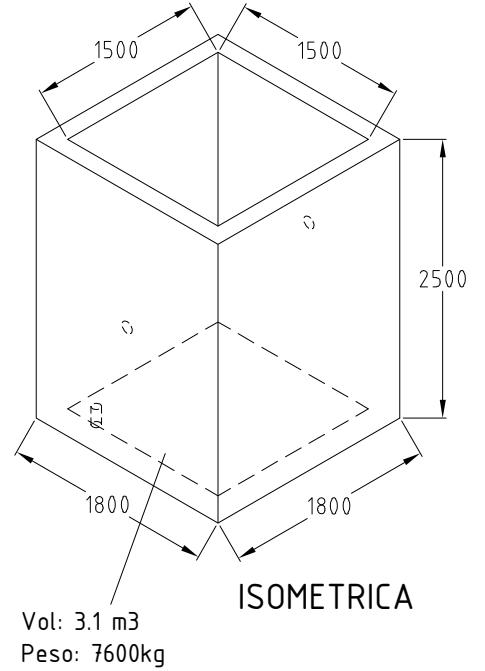
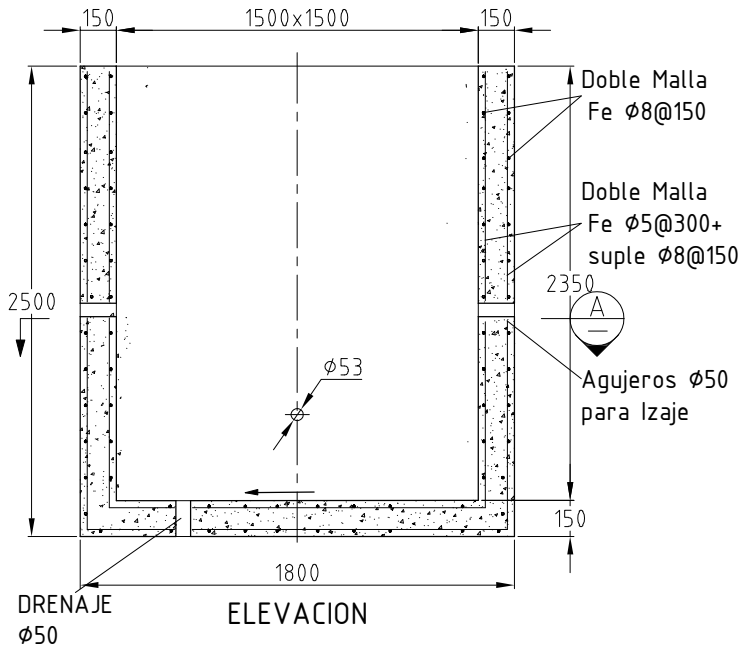
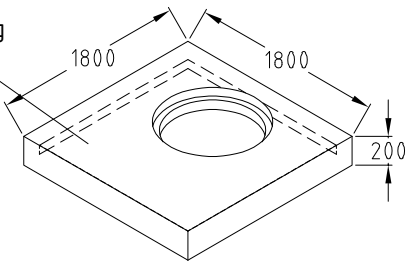

SECCION PLANTA

MATERIALES

HORMIGON : G-35
ACERO : A630-420

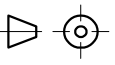
INGENIERIA Y PROYECTOS					 Prefabricados de Hormigón 	DESCRIPCION: CAMARA ELECTRICA 1500 x 1500 x 2500
	edición	modificación	fecha	nombre		
	NOMBRE		FECHA			
	Dibujó:	v. valdes	27-11-20			
Proyectó:	v. valdes	27-11-20		ESCALAS: INDICADAS		Nº PLANO PL - CE - 001
Aprobó:	m. morales	27-11-20				